



INSTALL GUIDE

2022 TOYOTA PRIUS PRIME PTS HYBRID AUTOMATIC



DOCUMENT NUMBER

A5683DA

REVISION DATE

20220106_135200

FIRMWARE

RSA-TL7

HARDWARE

CM-DC3

ACCESSORIES

ATTENTION: TO COMPLETE THIS INSTALLATION SOME ACCESSORIES MAY BE REQUIRED. VISIT OUR WEBSITE TO SEE ALL THE REQUIRED ACCESSORIES FOR YOUR VEHICLE.

TERMS OF USE

Automotive Data Solutions Inc. ("ADS") products are strictly intended for installation by Certified Technicians who are employed by a registered business specialized in the installation of automotive aftermarket electronics products. Prior to beginning installation of an ADS product in a vehicle, it is the Certified Technician's responsibility to review the most current Product Guide, Install Guide and vehicle-specific notes available in Weblink®. ADS is not responsible for any damages whatsoever, including but not limited to any consequential damages, incidental damages, damages for loss of time, loss of earnings, loss of profit, commercial loss, loss of economic opportunity and the like that may or may not have resulted from the use, misuse, improper installation or operation of its products. ADS reserves itself the right to suspend any Weblink® account without notice and decline to offer technical support to non-Certified Technicians, noncompliant Certified Technicians or end users.

REMOTE START	Supported
Data Immobilizer Bypass (no key required)	✓
Key Required for Immobilizer Bypass	
Takeover Available	
No Takeover Available (shutdown on unlock or door open)	✓
3x Lock Start from OEM Remotes	✓
Data / MUX Parking Light Control - Constant	✓
Data / MUX / Hazard Parking Light Control - Flashing	
Tach Monitoring	✓
Hood Status	✓
Brake Status	✓
E-Brake Status	✓
Glow Plug Status	
RAP Shutdown	

KEYLESS ENTRY	Supported
OEM Remotes Functional during RS	✓
OEM RFID Entry Sensors Functional during RS	✓
Door Lock	✓
Door Unlock	✓
Driver Door Priority Unlock	✓
Trunk/Hatch Release	
Power Liftgate	
Power Sliding Door (L)	
Power Sliding Door (R)	

SECURITY SYSTEM	Supported
Arm OEM Alarm	✓
Disarm OEM Alarm	✓
Aftermarket Alarm Control from OEM Remotes	✓
Aftermarket Alarm Control from OEM RFID Entry Sensors	✓
Door Status	✓
Trunk/Hatch Status	✓

COMFORT	Supported
Rear Defrost Activation	
Heated Mirror Activation	
Heated Seat Activation	
Cooled Seat Activation	
Heated Steering Wheel Activation	

MODULE CONNECTORS

CONNECTOR PINOUT

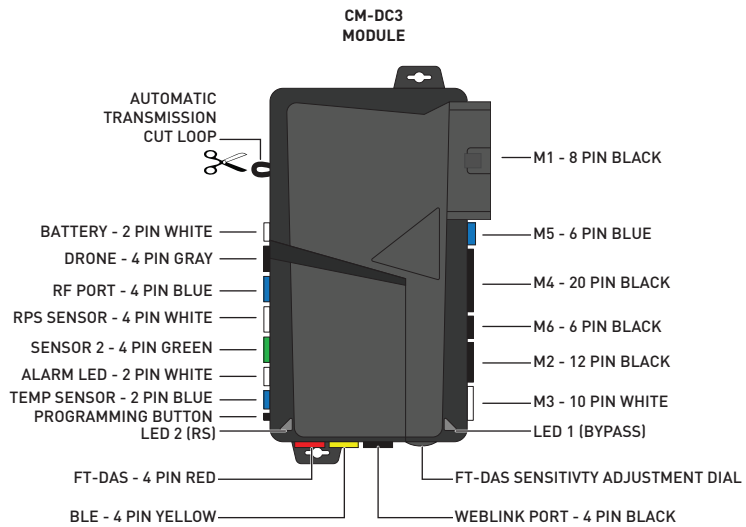

Connector	Pin	Function
M1	1	01 ORANGE - ACCESSORY (+)
	2	02 RED - POWER (30A)
	3	03 PURPLE - STARTER (+)
	4	04 PINK/WHITE - PROG. RELAY #4 - IGNITION 2 (+) [DEFAULT]
	5	05 PINK - IGNITION (+)
	6	06 WHITE - PROG. RELAY #5 (10A) - PARKING LIGHTS (+) [DEFAULT]
	7	07 RED - POWER (30A)
	8	08 BLACK - GROUND
M2	1	01 GREEN•BLACK DOT - LOCK (-) OUTPUT
	2	02 BLUE•BLACK DOT - UNLOCK (-) OUTPUT
	3	03 RED/WHITE•BLACK DOT - TRUNK RELEASE (-) OUTPUT
	4	04 GREEN/WHITE•BLACK DOT - ARM (-) OUTPUT
	5	05 GREEN/BLACK•BLACK DOT - DISARM (-) OUTPUT
	6	06 BLUE/WHITE•BLACK DOT - GWR (-) OUTPUT
	7	07 BROWN•BLACK DOT - SIREN (+) OUTPUT
	8	08 WHITE/PURPLE•BLACK DOT - POC 1 - 2ND UNLOCK OTHER DOORS (-) OUTPUT
	9	09 PURPLE/BLACK•BLACK DOT - POC 2 - RAP SHUTDOWN (-) OUTPUT
	10	10 WHITE/BLACK•BLACK DOT - POC 3 - HORN (-) OUTPUT
	11	11 BROWN/BLACK•BLACK DOT - POC 4 - STARTER KILL (-) OUTPUT
	12	12 WHITE•BLACK DOT - PARKING LIGHTS (-) OUTPUT
M3	1	01 BROWN•SILVER DOT - BRAKE (+) INPUT
	2	02 BLACK/WHITE•SILVER DOT - E-BRAKE (-) INPUT
	3	03 PURPLE•SILVER DOT - DOOR (+) INPUT
	4	04 GREEN•SILVER DOT - DOOR (-) INPUT
	5	05 PURPLE/WHITE•SILVER DOT - TACH (-) INPUT
	6	06 WHITE/BLUE•SILVER DOT - X-TRIGGER (-) INPUT
	7	07 GRAY•SILVER DOT - HOOD (-) INPUT
	8	08 BLUE•SILVER DOT - TRUNK (-) INPUT
	9	09 GRAY/BLACK•SILVER DOT - GLOW PLUG (+) INPUT
	10	10 TAN•SILVER DOT - EXT ALARM SENSOR (-) INPUT
M4		FUNCTIONS DEFINED BY FIRMWARE
M5		FUNCTIONS DEFINED BY FIRMWARE
M6		FUNCTIONS DEFINED BY FIRMWARE

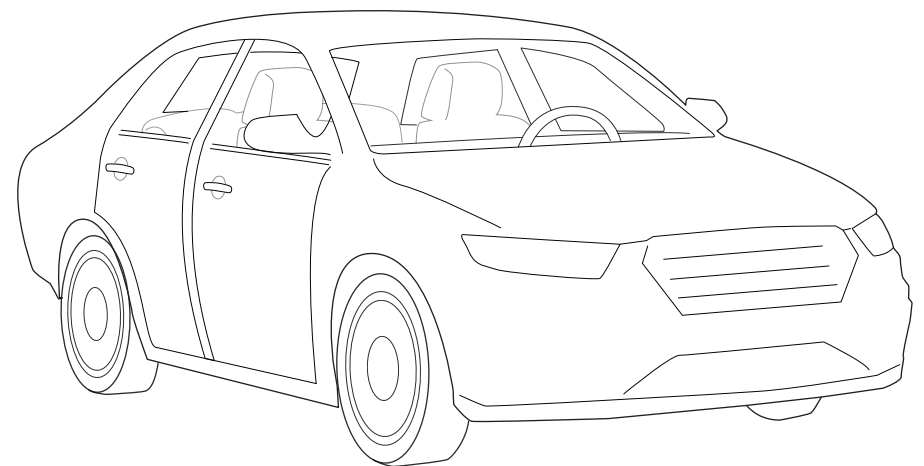
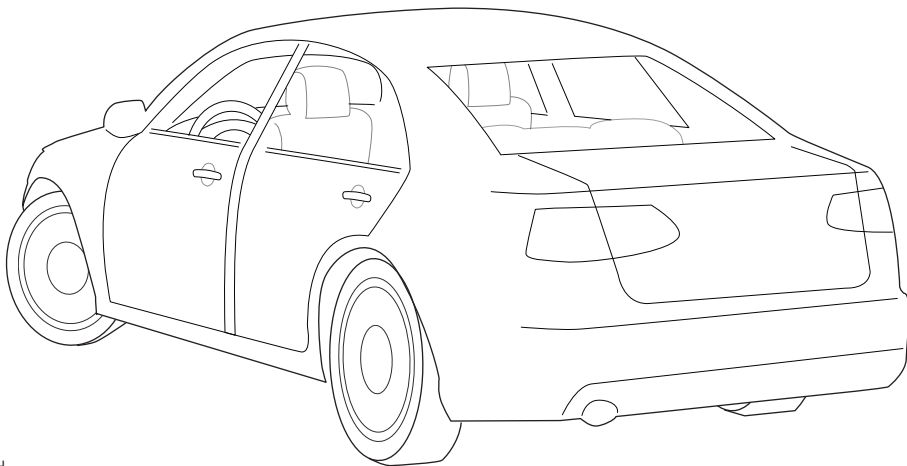
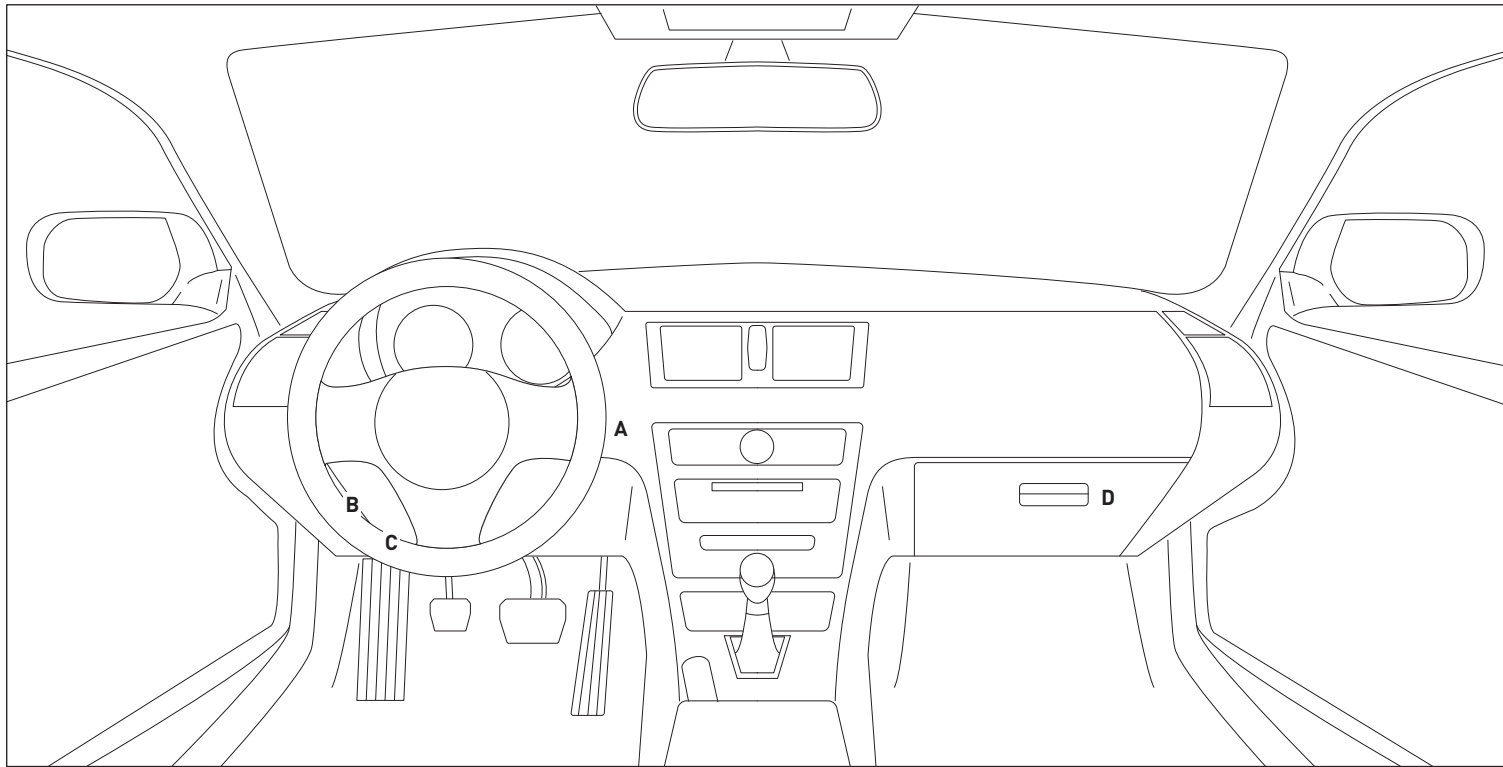

⚠ CUT LOOP FOR AUTOMATIC TRANSMISSION ONLY

⚠ SOME PARTS OF THE T-HARNESS (JS3, JS4 AND JS8-TL6) ARE NOT USED IN THIS INSTALL DO NOT CONNECT THEM.

⚠ NOT REQUIRED FOR BASIC INSTALLATION. INSERT WIRE TERMINALS IN MS3 CONNECTOR FOR OPTIONAL OUTPUTS. REFER TO PRODUCT GUIDE FOR MORE INFORMATION.

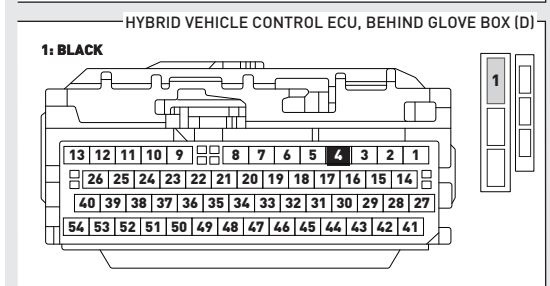
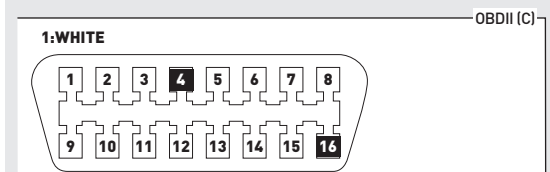
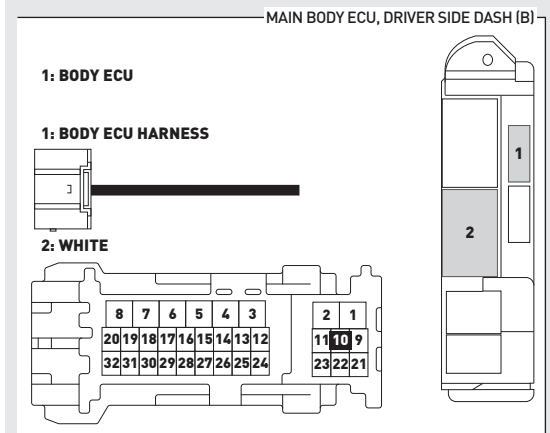
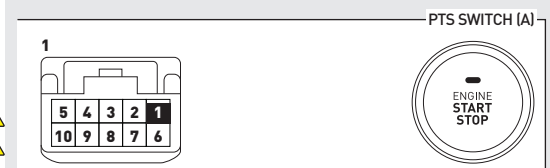
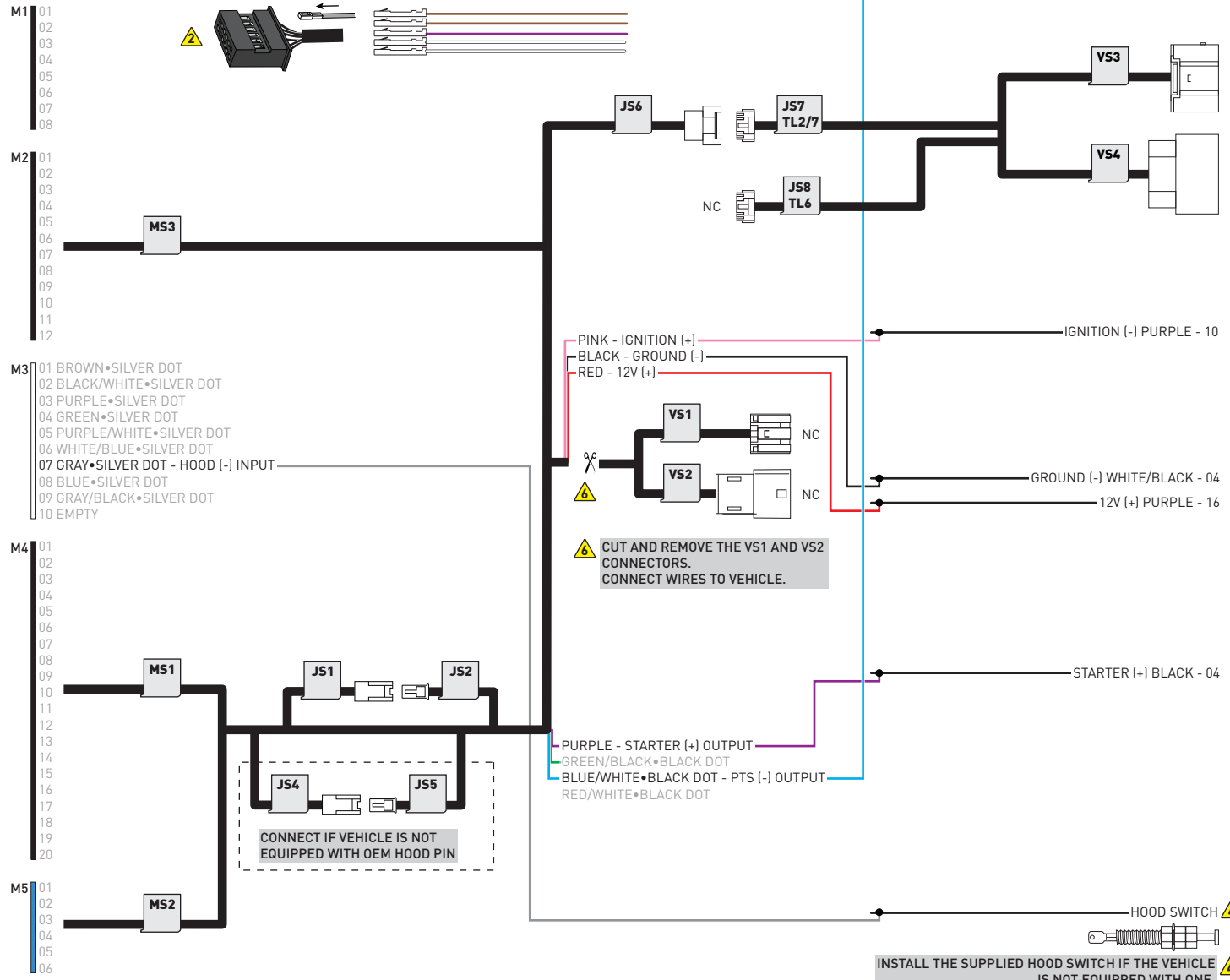

IMPORTANT:

1 - NO TAKEOVER AVAILABLE. UPON OPENING VEHICLE DOOR ENGINE WILL SHUTDOWN.

2 - ALL DOORS MUST BE CLOSED TO REMOTE START VEHICLE.

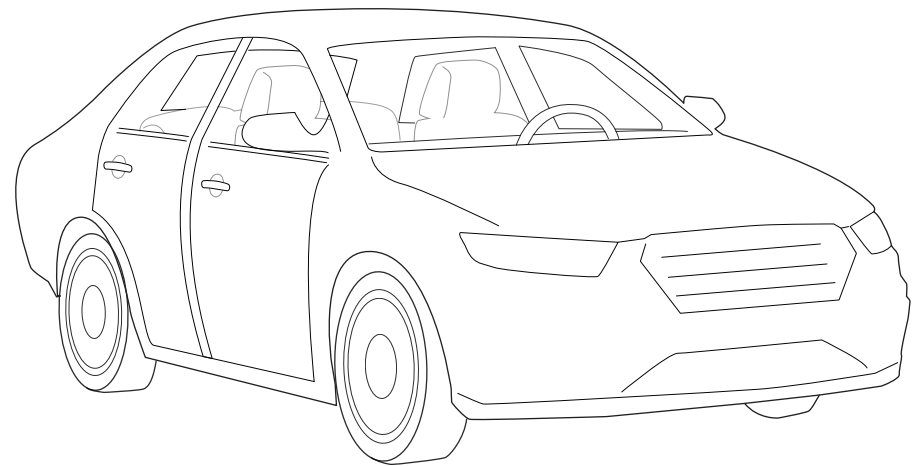
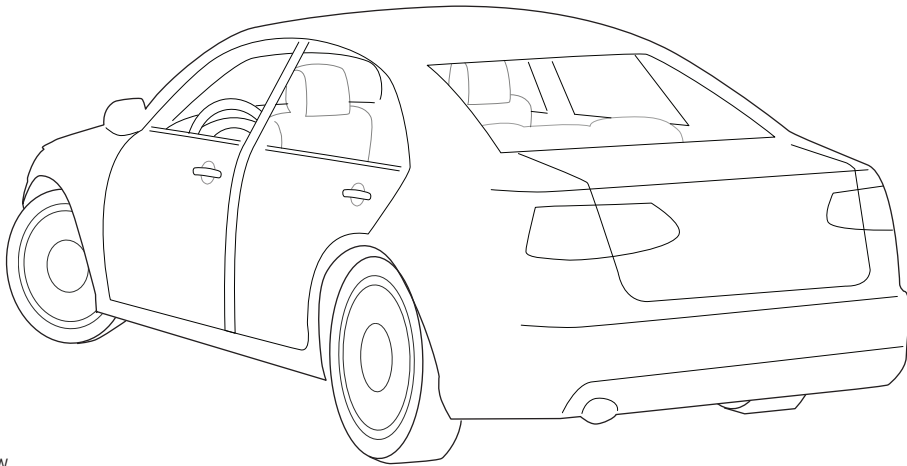
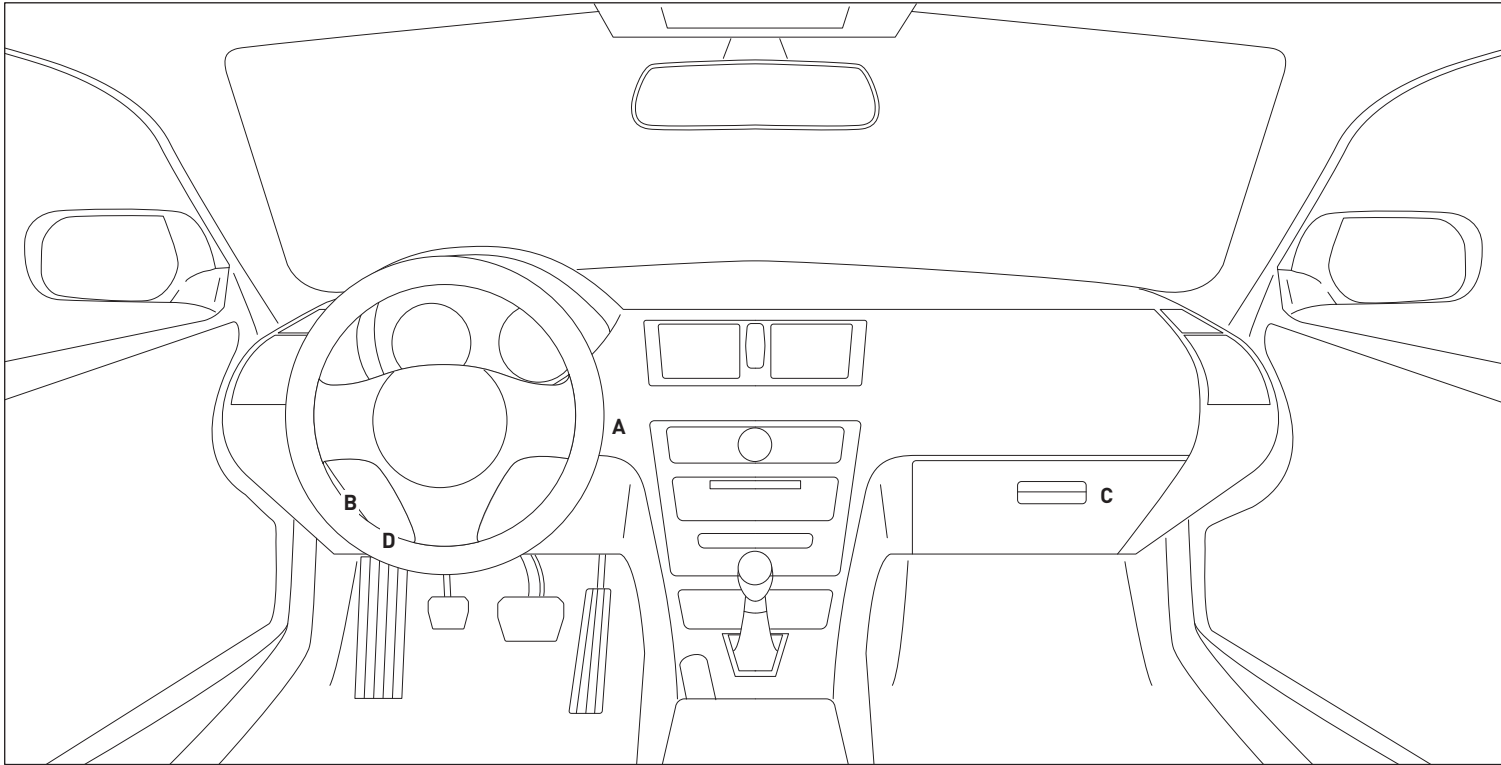

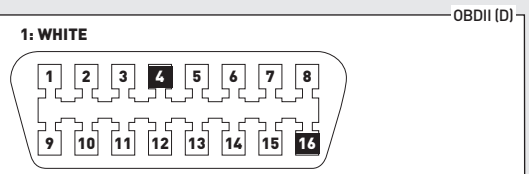
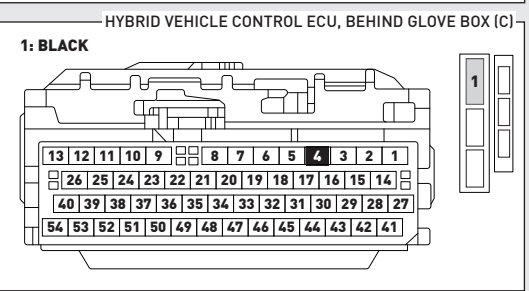
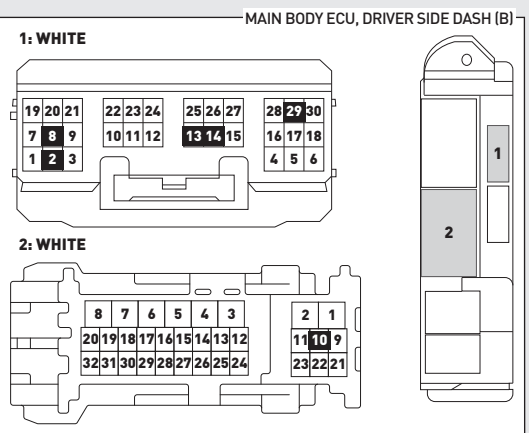
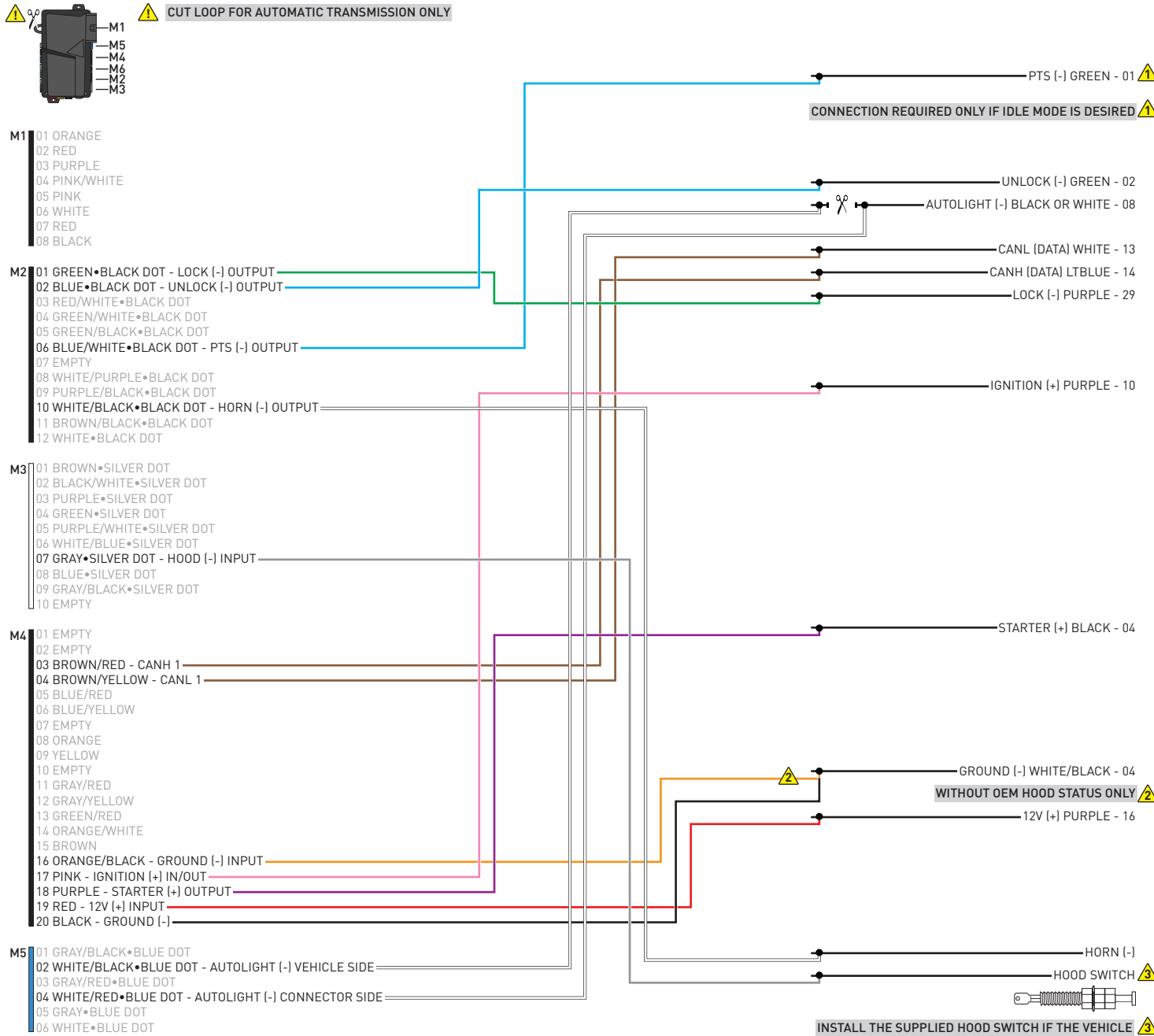

1 - NO TAKEOVER AVAILABLE. UPON OPENING VEHICLE DOOR ENGINE WILL SHUTDOWN. ⚠

2 - ALL DOORS MUST BE CLOSED TO REMOTE START VEHICLE. ⚠

>>



IMPORTANT: The hood must be closed.

01



Push start button twice [2x] to ON position.

02



Wait, if LED 1 turns solid GREEN for 2 seconds, proceed to step 7. If LED 1 flashes GREEN rapidly, proceed to step 3.

03



Push start button once [1x] to OFF position.

04



Wait, LED 1 will turn solid RED. (This may take up to 5 minutes.)

05



Push start button twice [2x] to ON position.

06



Wait, LED 1 will turn solid GREEN for 2 seconds.

07



Push start button once [1x] to OFF position.

08



START vehicle for 15 seconds.

09



Press and hold the brake pedal.

10



Press and release the module's programming button.

11



Release the brake pedal.

12

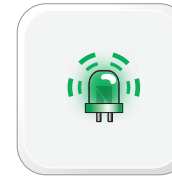

Wait, LED 2 will flash GREEN.

13

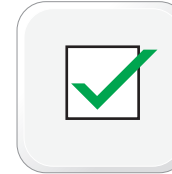

Module Programming Procedure completed.

REMOTE STARTER ERROR CODES: NOTES	PARKING LIGHT FLASHES	DIAGNOSTIC
<p>I WARNING: The following applies only when the parking lights are connected and supported by the system.</p> <p>II After a remote starter failure, the parking lights will flash three [3x] times followed by the error code. See table.</p>	3 + 1	Tach is not programmed OR engine is already running.
	3 + 2	Key is in ignition ON position.
	3 + 3	Door is open.
	3 + 4	Trunk is open.
	3 + 5	Foot brake is ON.
	3 + 6	Hood is open.
	3 + 7	Loop is not cut.
	3 + 8	No tach detected.
	3 + 9	Vehicle movement detected (VSS).
	3 + 10	System is in Valet Mode.
	3 + 11	CAN communication failure
	3 + 12	RS not synchronized. Start vehicle with OEM key for 15 sec before trying a new RS sequence.
	3 + 13	Bypass problem.
	3 + 14	Idle mode or takeover is not available on this vehicle.
	3 + 15	Overheat protection.

REMOTE STARTER SHUTDOWN ERROR CODES: NOTES	PARKING LIGHT FLASHES	DIAGNOSTIC
<p>I WARNING: The following applies only when the parking lights are connected and supported by the system.</p> <p>II If the engine shuts down after a remote starter sequence use the query command from a compatible aftermarket remote to display the shutdown error code. The parking lights will flash four [4x] times followed by the error code. See table.</p>	4 + 1	Engine tach signal was lost.
	4 + 2	Emergency brake signal was lost.
	4 + 3	Foot brake ON detected.
	4 + 4	Hood open detected.
	4 + 5	Tach over rev detected.
	4 + 6	Glow plug timeout error.
	4 + 7	Vehicle movement detected (VSS).
	4 + 8	Check engine light ON.
	4 + 9	Low fuel level.
	4 + 10	Open door detected.
	4 + 11	CAN communication failure during RS sequence.
	4 + 12	RS not synchronized. Start vehicle with OEM key for 15 sec before trying a new RS sequence.
	4 + 13	Bypass problem.
	4 + 14	Idle mode or takeover is not available on this vehicle.
	4 + 15	Overheat protection.

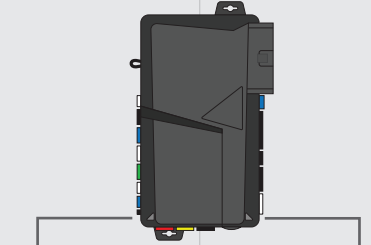
MODULE STATUS DURING:			LED STATUS	DIAGNOSTIC
	LED 2*	LED 1**		
MODULE PROGRAMMING		●	Flashing RED	Missing/wrong information from firmware or vehicle. See firmware specific diagnostics, or contact technical support.
		●	Solid RED	Module waiting for more vehicle information. Programming incomplete.
		●	Flashing GREEN	Additional steps required to complete programming. Refer to install guide.
		●	Solid GREEN then OFF	Module programming completed successfully.
		○	OFF	No activity or module already programmed.
	●		1 RED flash	No firmware on module. Connect to Weblink and flash device.
	●●		2 ORANGE flashes	Contact technical support.
	●●●		3 ORANGE flashes	Module programming not completed.
	●●●●		4 ORANGE flashes	Contact technical support.
	●●●●●		7 ORANGE flashes	Contact technical support.
	●●●●●●		8 ORANGE flashes	Loop not cut. Ensure loop is cut for automatic transmission. Reset and re-learn.
●●●●●●●		9 ORANGE flashes	Loop not cut. Ensure loop is cut for automatic transmission. Reset and re-learn.	
●●●●●●●●		10 ORANGE flashes	Boot loader update failed. Contact technical support.	
●●●●●●●●●		11 ORANGE flashes	T-harness detection does not match install type selection in Weblink.	
TACH PROGRAMMING		●	Solid RED	Tach learn in progress.
		●	1 GREEN flash	Tach signal programmed in analog.
		●●	2 GREEN flashes	Tach signal programmed in data.
		●●●	3 RED flashes	No tach signal detected
		●●●●	4 RED flashes	System is in valet mode. Turn off valet mode to program tach.
		●●●●●	6 RED flashes	Engine sensing set for 'assumed start'. No tach programming required.
		●●●●●●	7 ORANGE flashes	Engine sensing not configured properly. Contact technical support.

* LED 2 (RS) displays generic diagnostic codes specific to the remote start module. Orange LED flashes may appear red.

** LED 1 (Bypass) displays diagnostic codes specific to the firmware loaded on the module.

Visit the programming diagnostics page for more information.

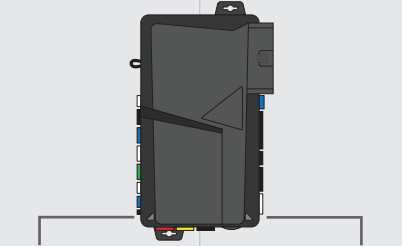

MODULE STATUS DURING:			LED STATUS	DIAGNOSTIC
	LED 2*	LED 1**		
REMOTE START SEQUENCE	●		Flashing rapid RED	Remote start shutdown sequence.
	●		Flashing slow RED	Remote start shutdown error code. Contact technical support.
	●		Solid RED	Remote start crank delay.
	●		Flashing rapid GREEN	Remote start cycle in progress. Working correctly.
	●		1 GREEN flash	Remote start initiated successfully.
	●		3 GREEN flashes	Idle mode cycle in progress.
	●		4 GREEN flashes	Turbo mode cycle in progress.
TRANSMITTER PROGRAMMING		●	Flashing GREEN	Remote start cycle in progress. Displays vehicle platform during runtime.
		●	Rapid GREEN flashing	Secure takeover initiated. Waiting to complete takeover after brake press.
	●		Solid RED	Remote programming in progress, waiting for remote pairing.
	●		1 GREEN flash	Remote programmed.
	●		4 RED flashes	Shutdown remote starter before attempting remote programming.
	●		5 RED flashes	Engine must be off before attempting remote programming.
	●		6 RED flashes	System must be unlocked/disarmed before attempting remote programming.
			7 RED flashes	Module must be learned to the vehicle before attempting remote programming.

* LED 2 (RS) displays generic diagnostic codes specific to the remote start module. Orange LED flashes may appear red.

** LED 1 (Bypass) displays diagnostic codes specific to the firmware loaded on the module.

Visit the programming diagnostics page for more information.

